

1

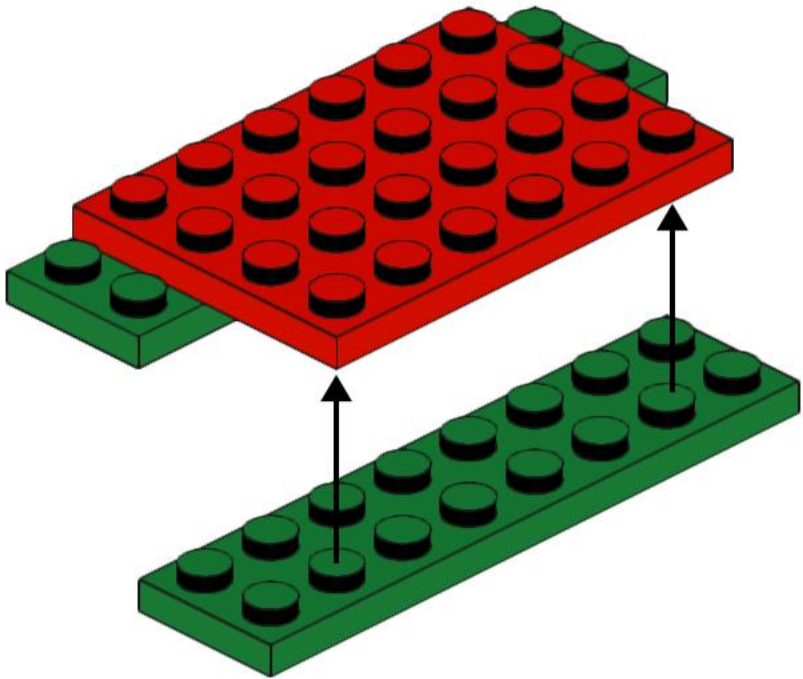

2

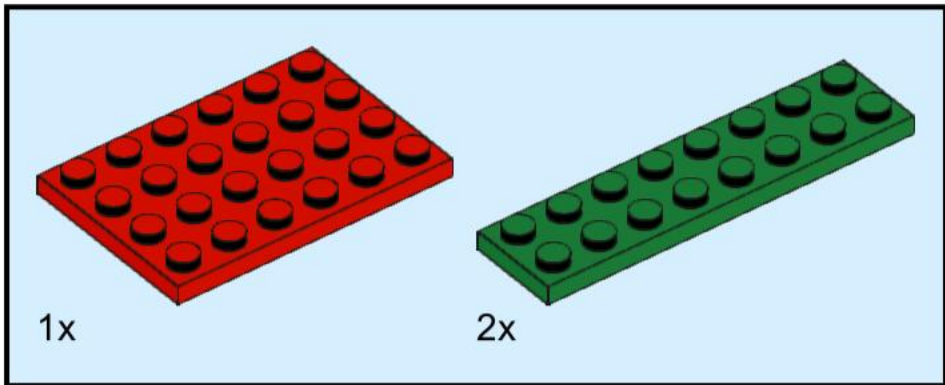
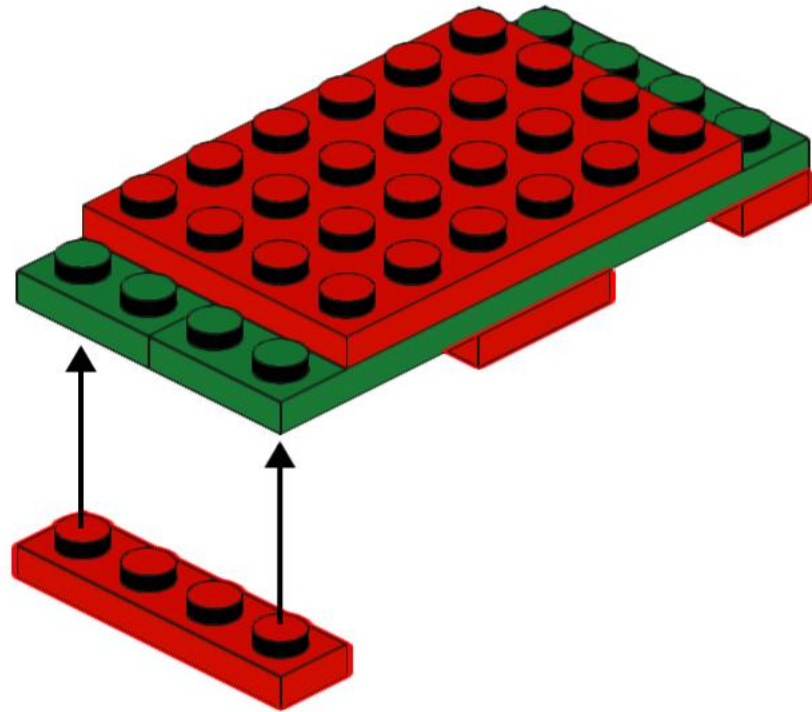
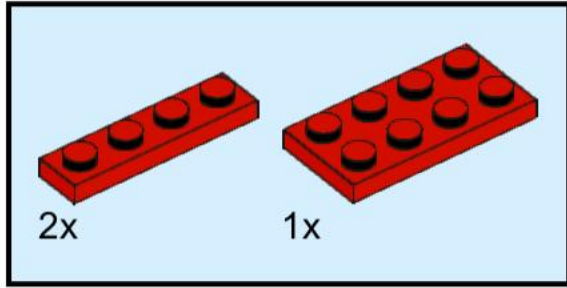

3

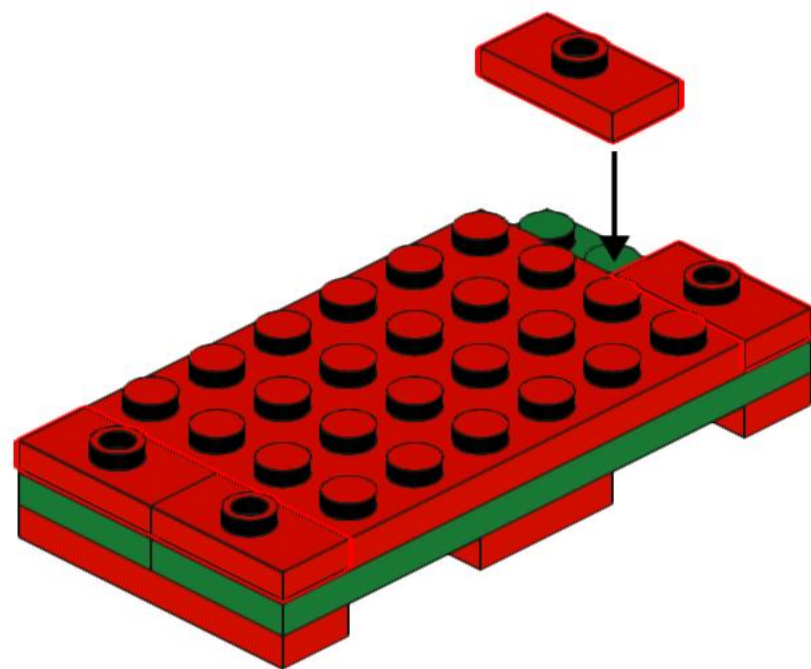
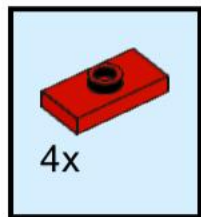

5

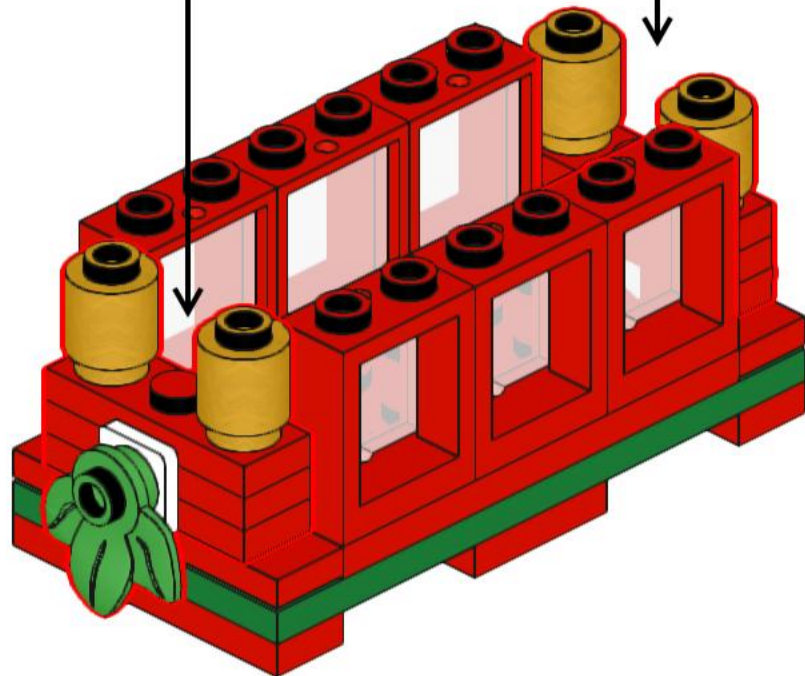
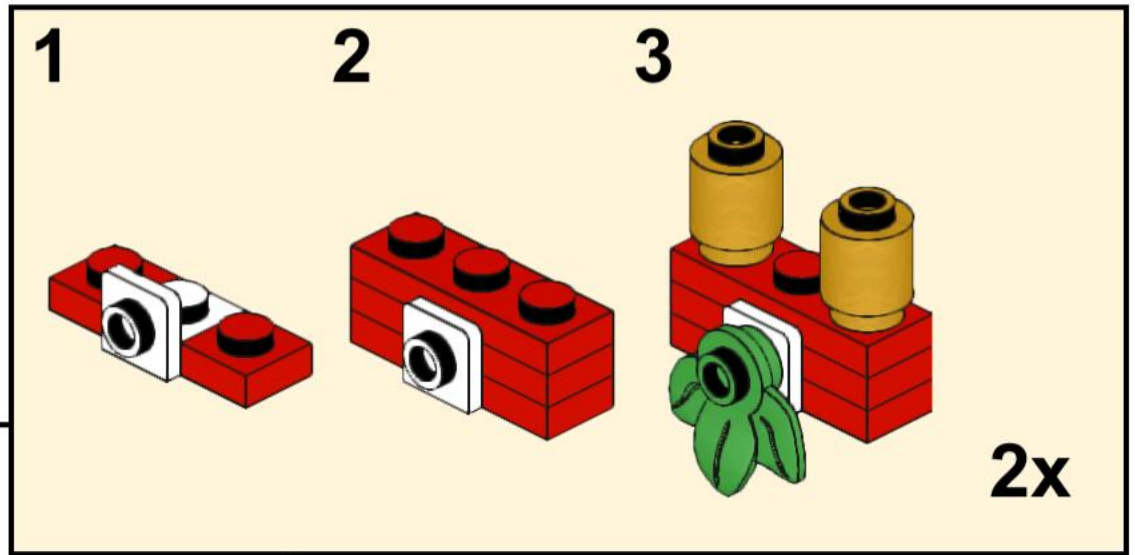
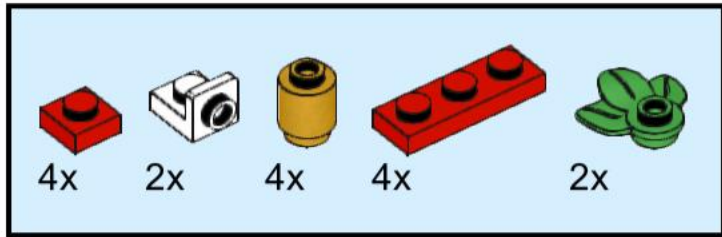

6

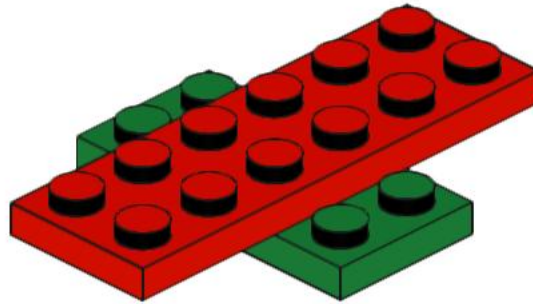
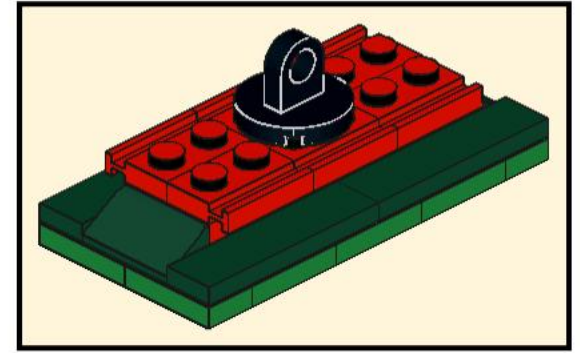
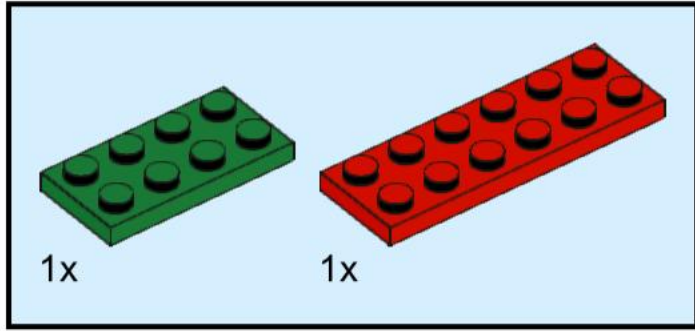

7

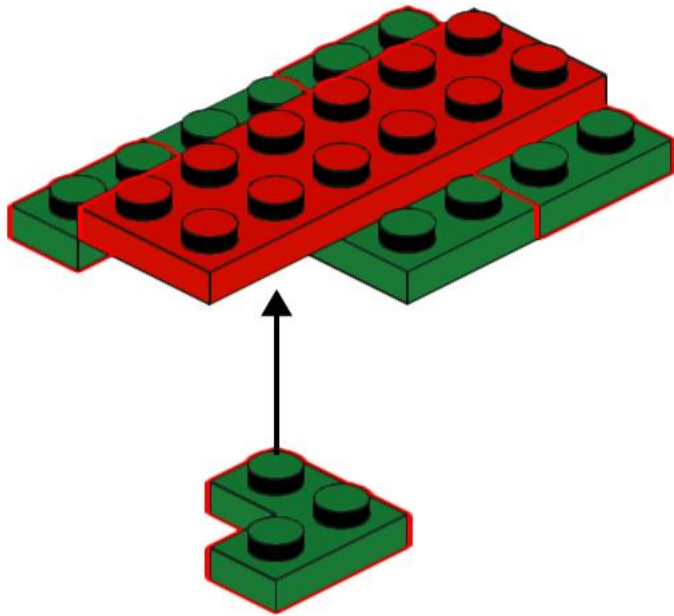
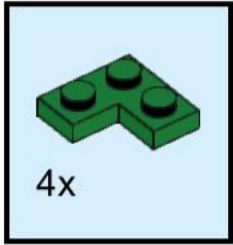

8

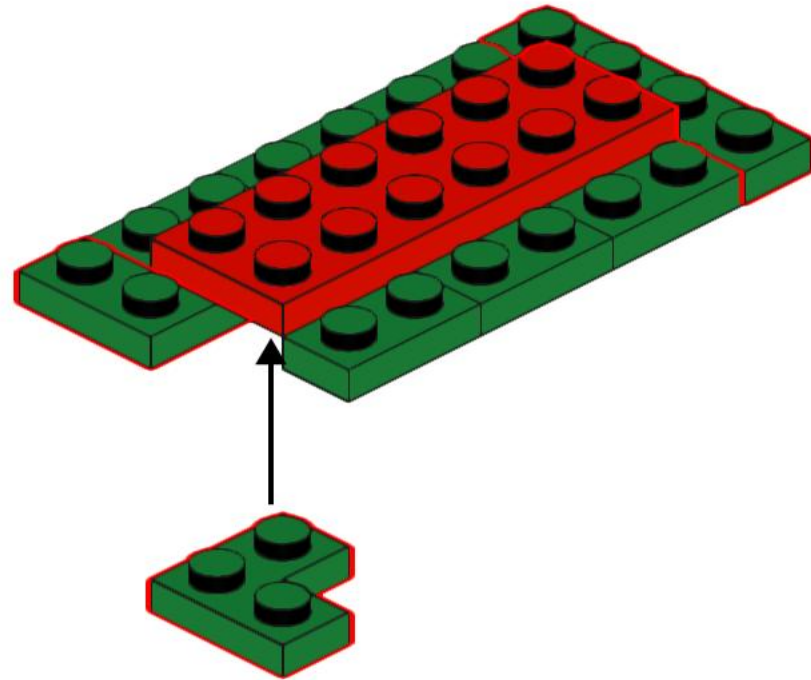
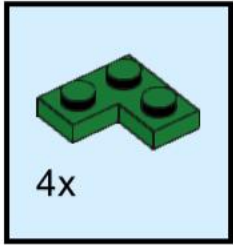

9

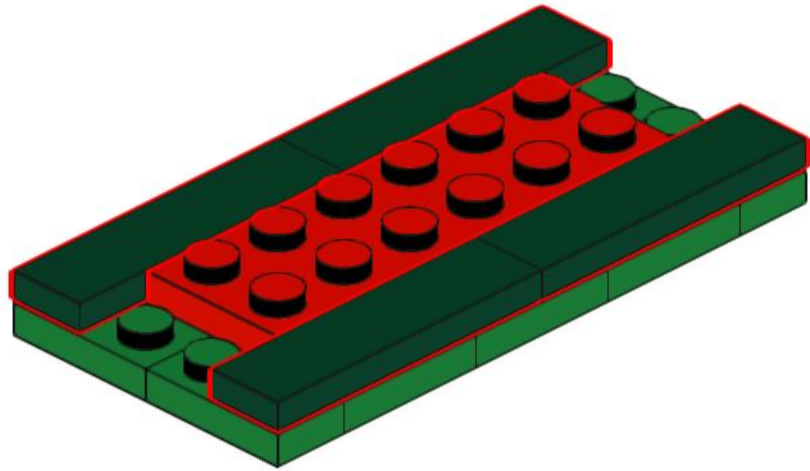
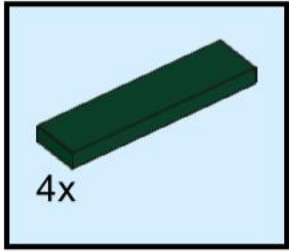

10

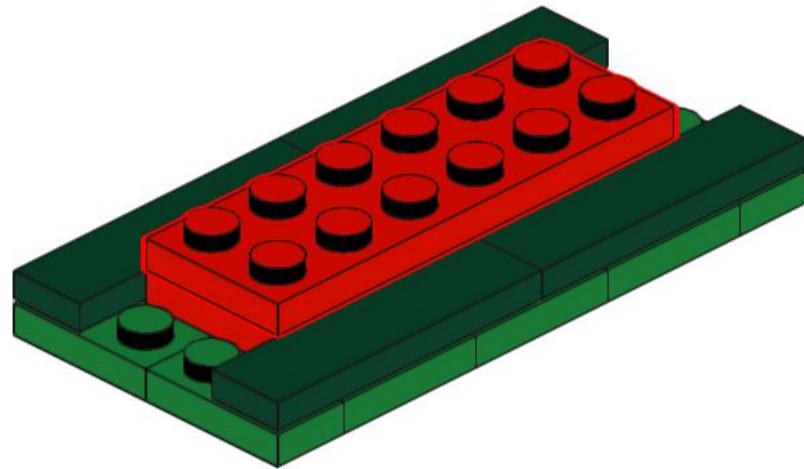
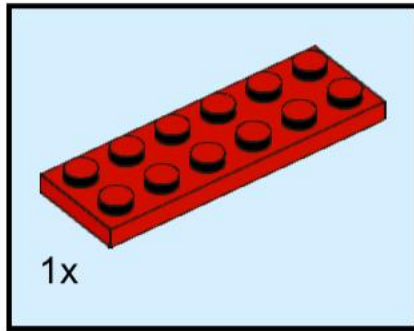

11

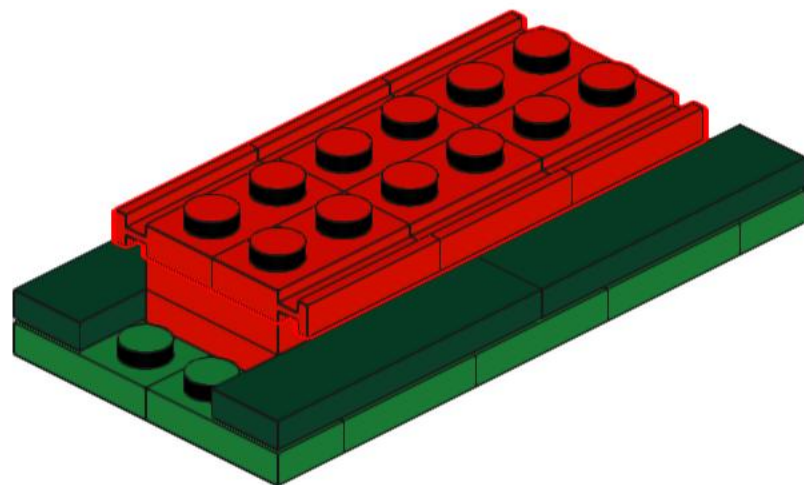
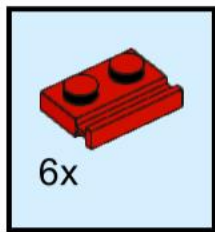

12

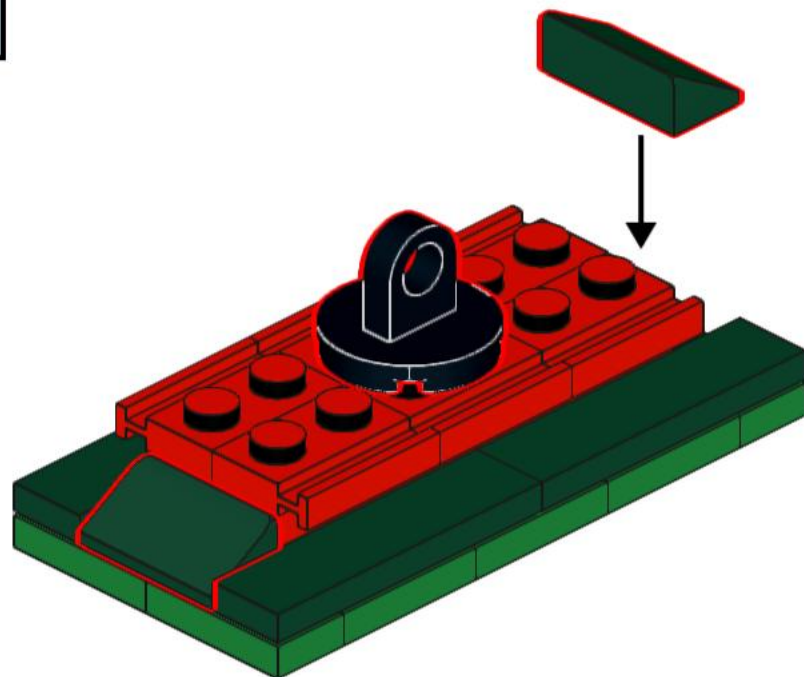
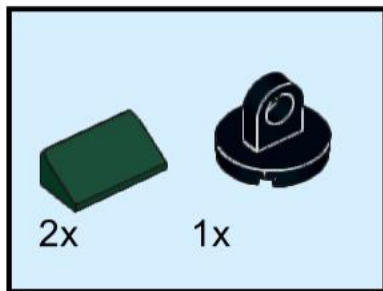

13

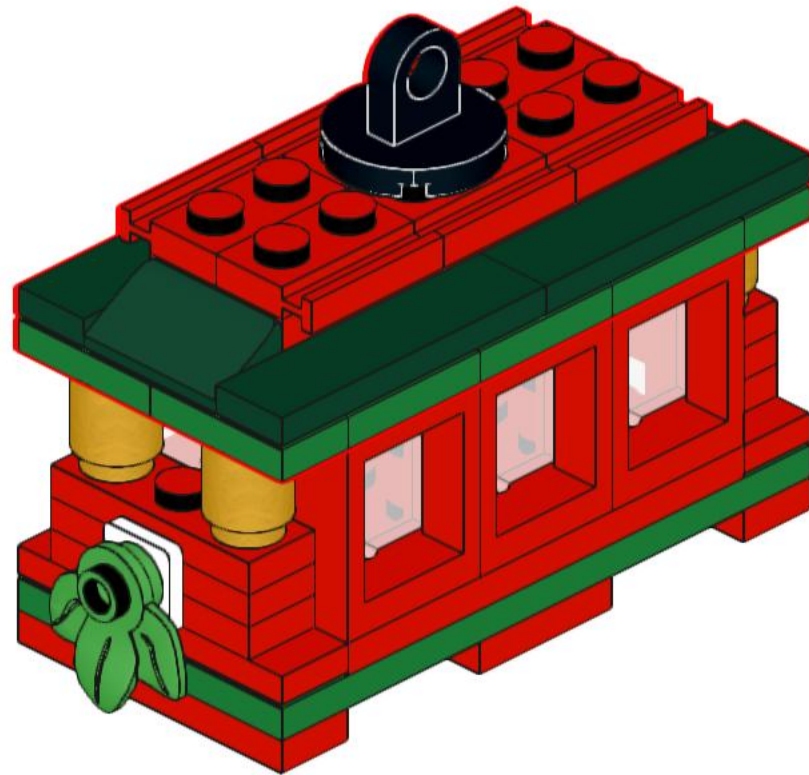

14

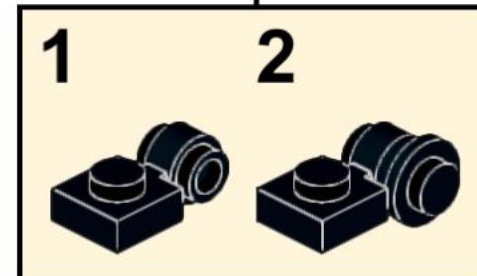
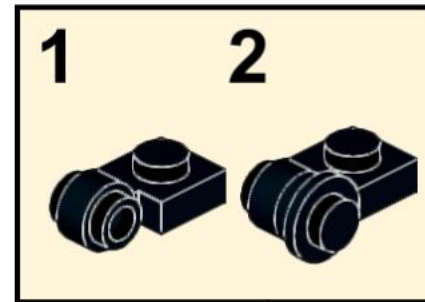
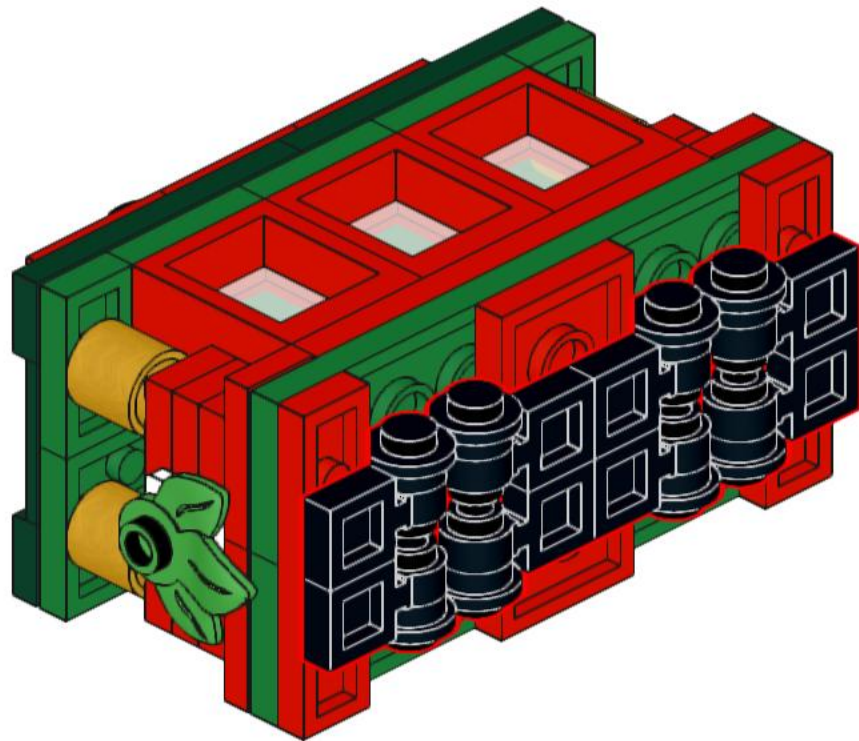
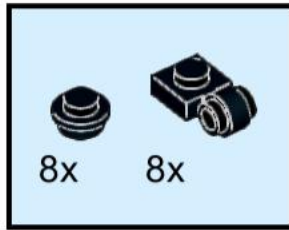

15

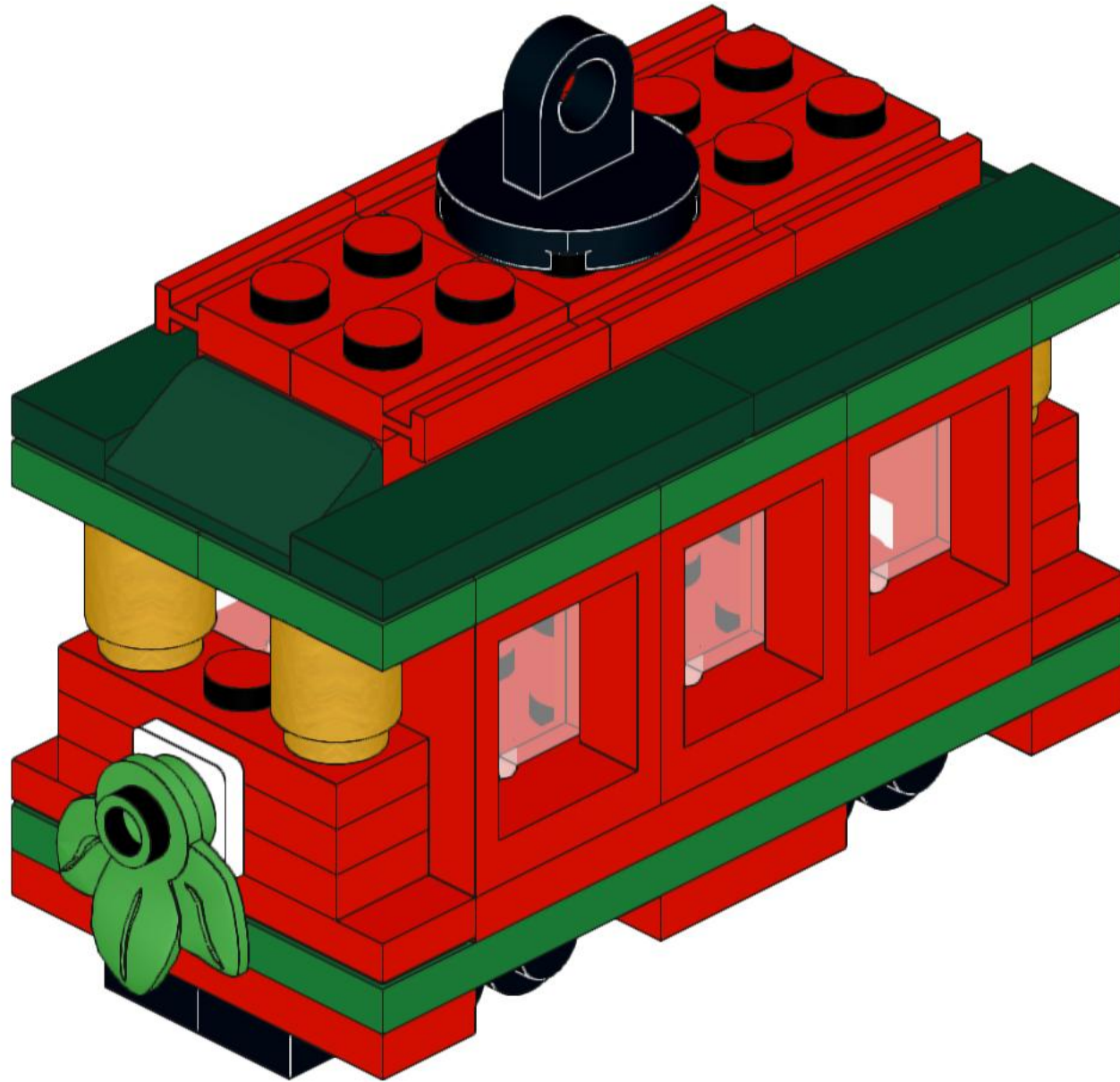





8x
4073, 11

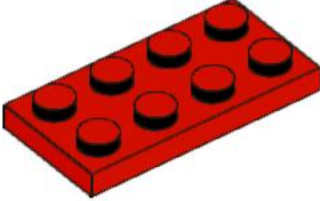

4x
15573, 5



1x
3020, 5



4x
2431, 80



2x
32607, 36



8x
4081b, 11

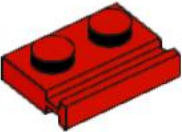

6x
32028, 5

1x
3020, 5



8x
2420, 6

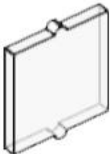

6x
60601, 12



1x
2376, 11

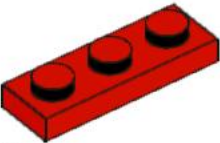

4x
3623, 5

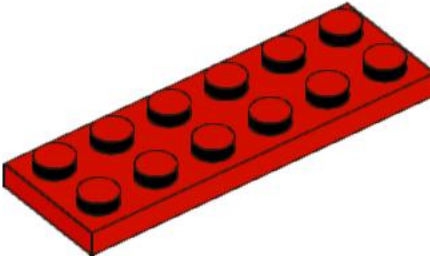

2x
3795, 5

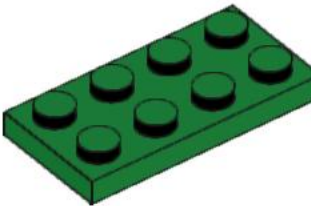

1x
3020, 6



4x
3062b, 115



2x
36840, 1

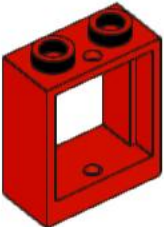

6x
60592, 5

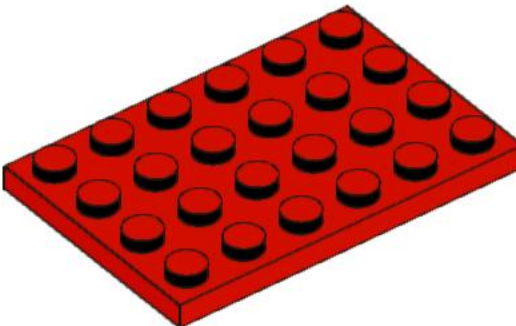

1x
3032, 5

1x
3020, 6



4x
3024, 5

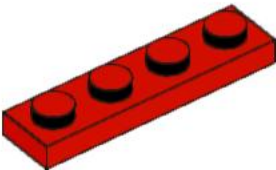

2x
3710, 5

1x
3032, 5

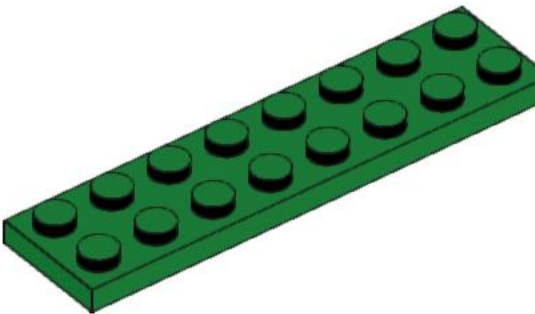

2x
3034, 6



2x
85984, 80