

1

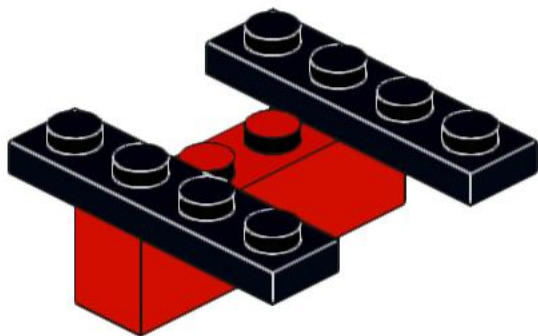

2

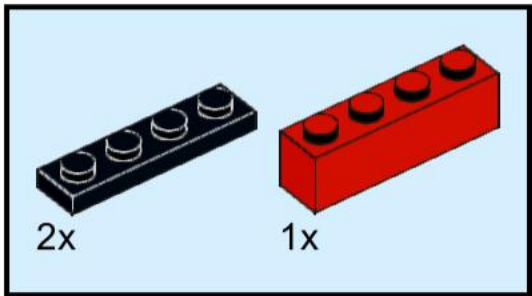
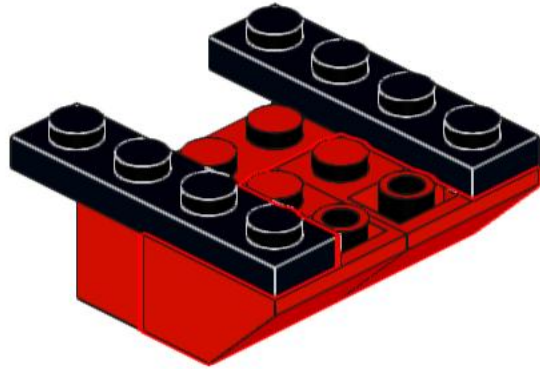
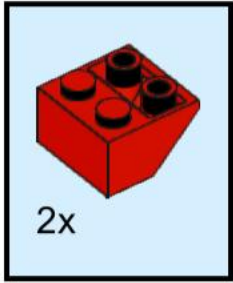

3

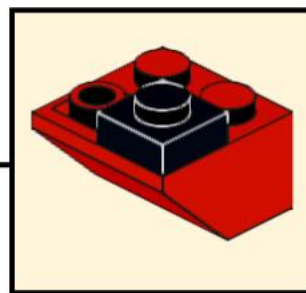
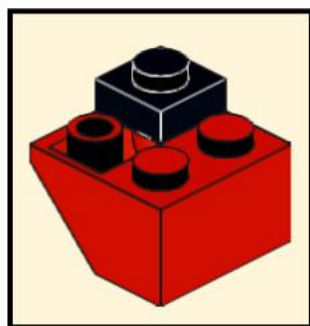
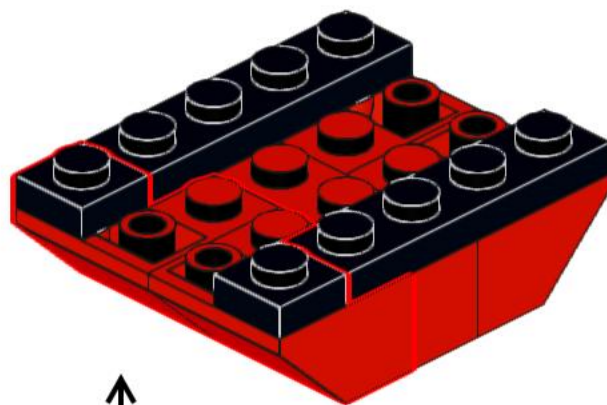
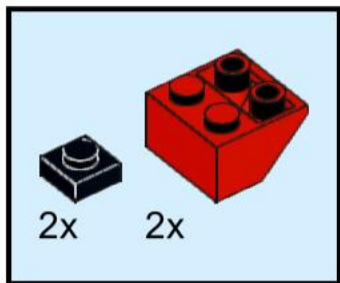

4

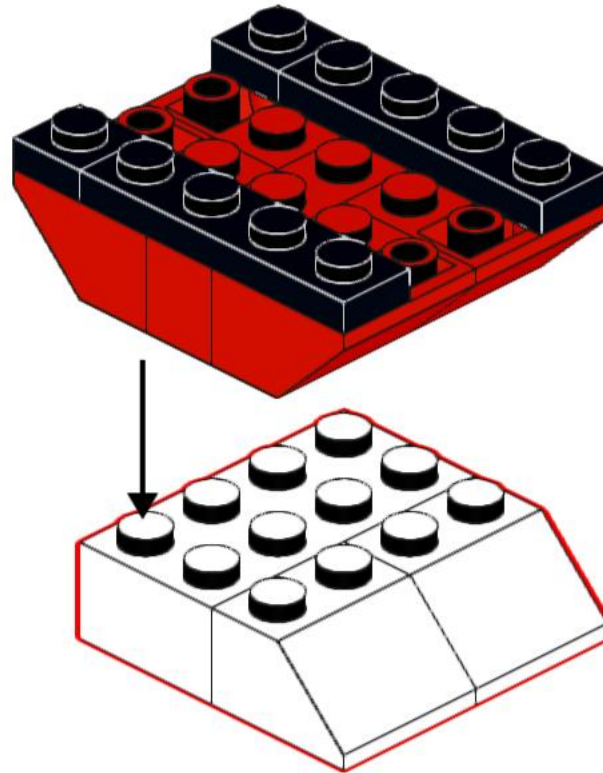
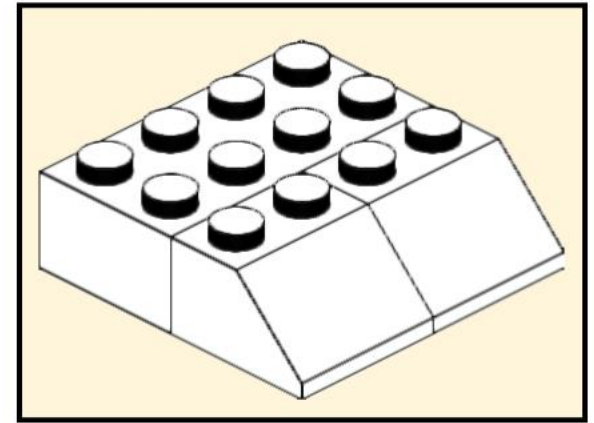
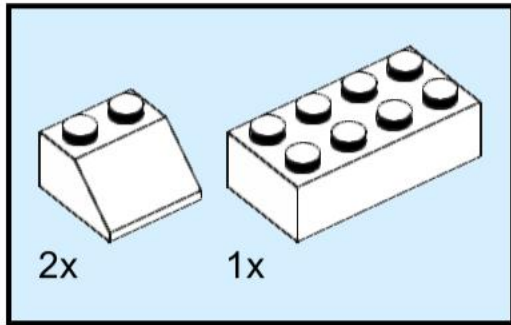

5

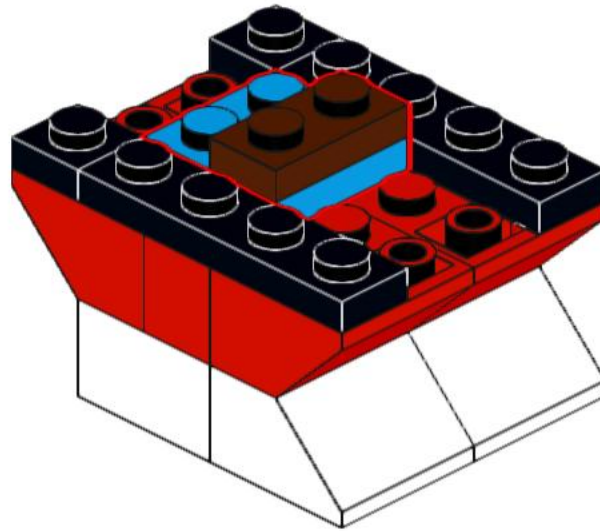
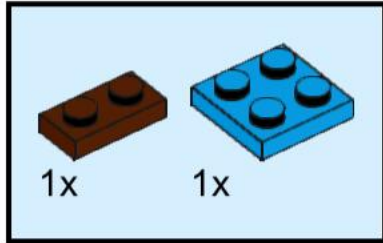

6

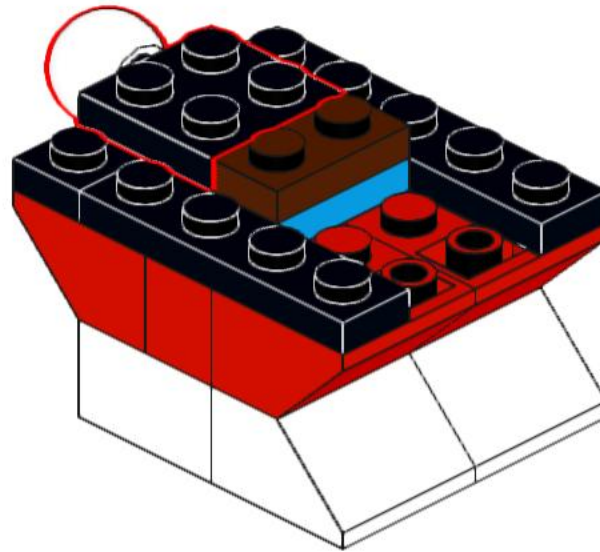
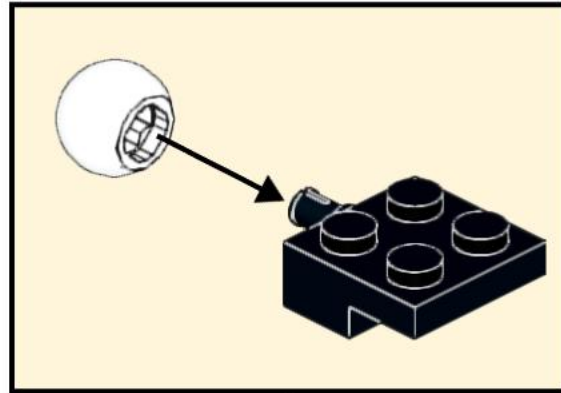
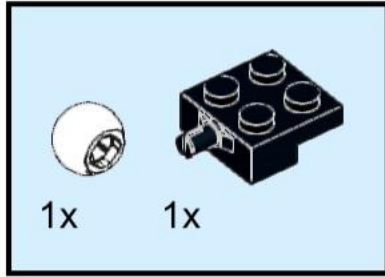

7

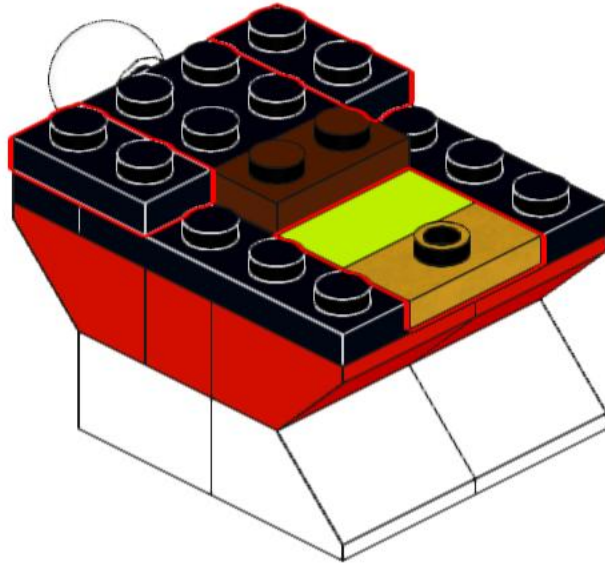
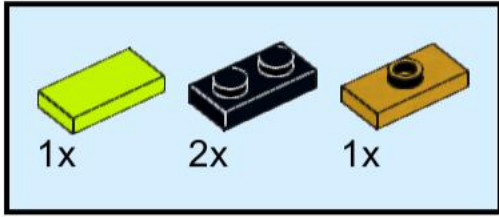

8

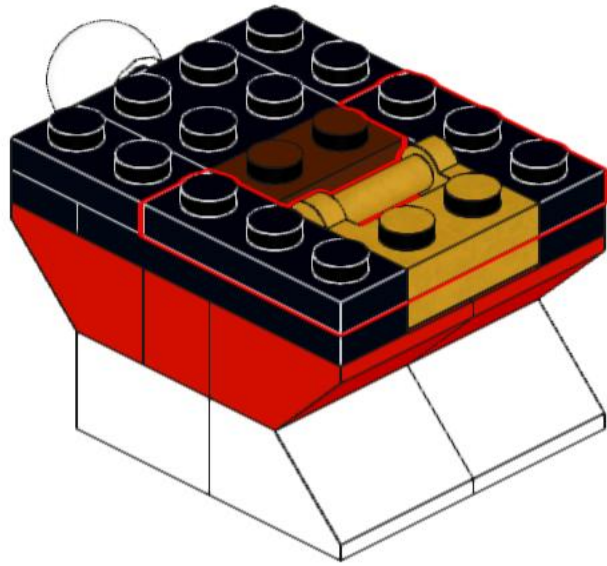
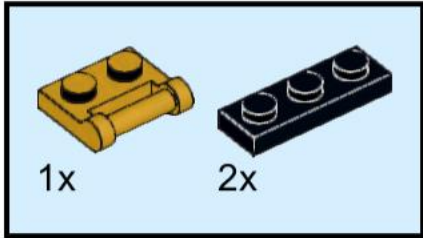



9

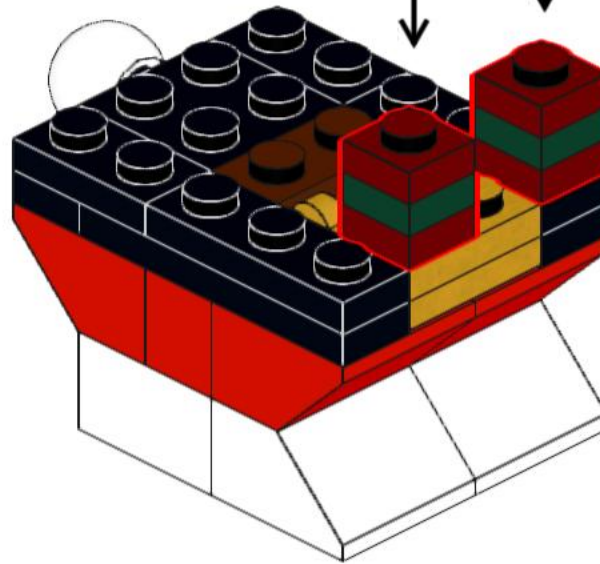
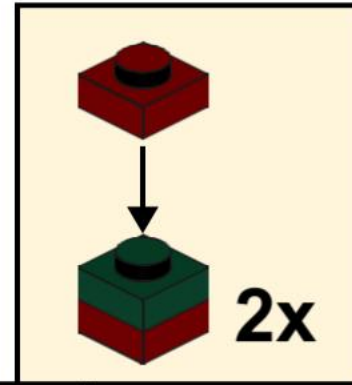
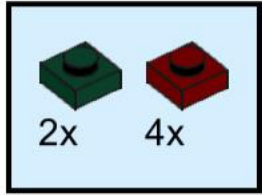

# 10

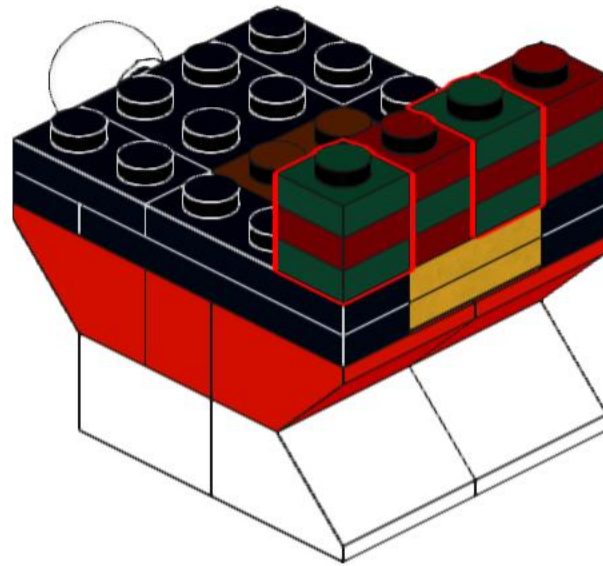
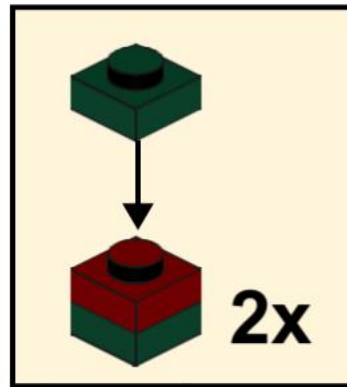
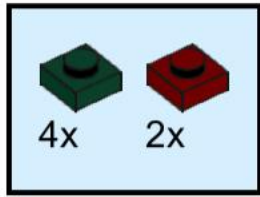

# 11

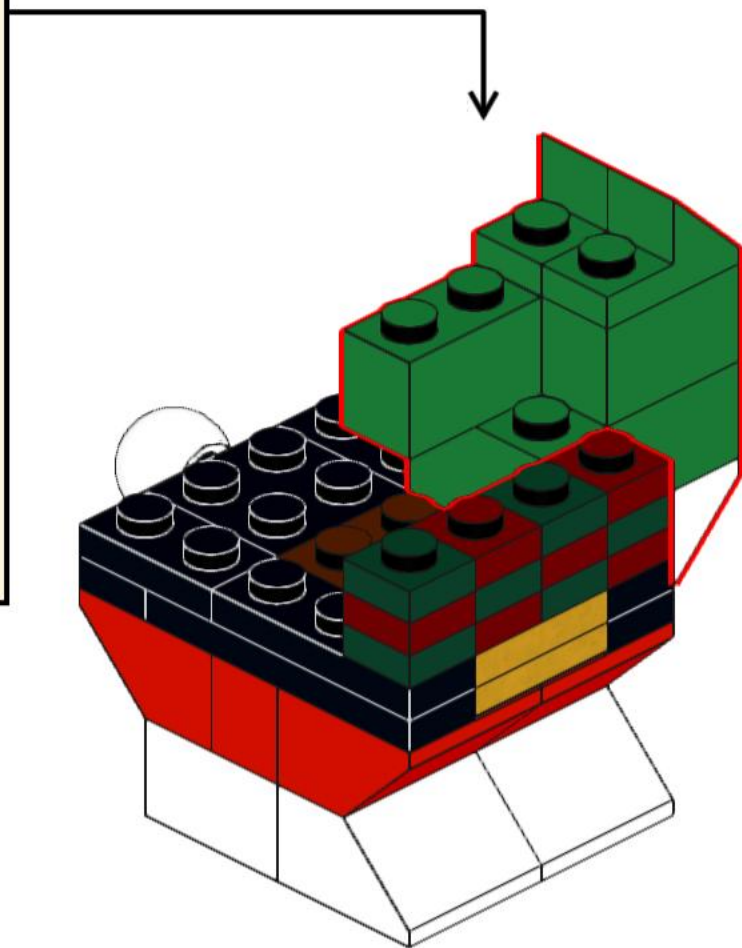
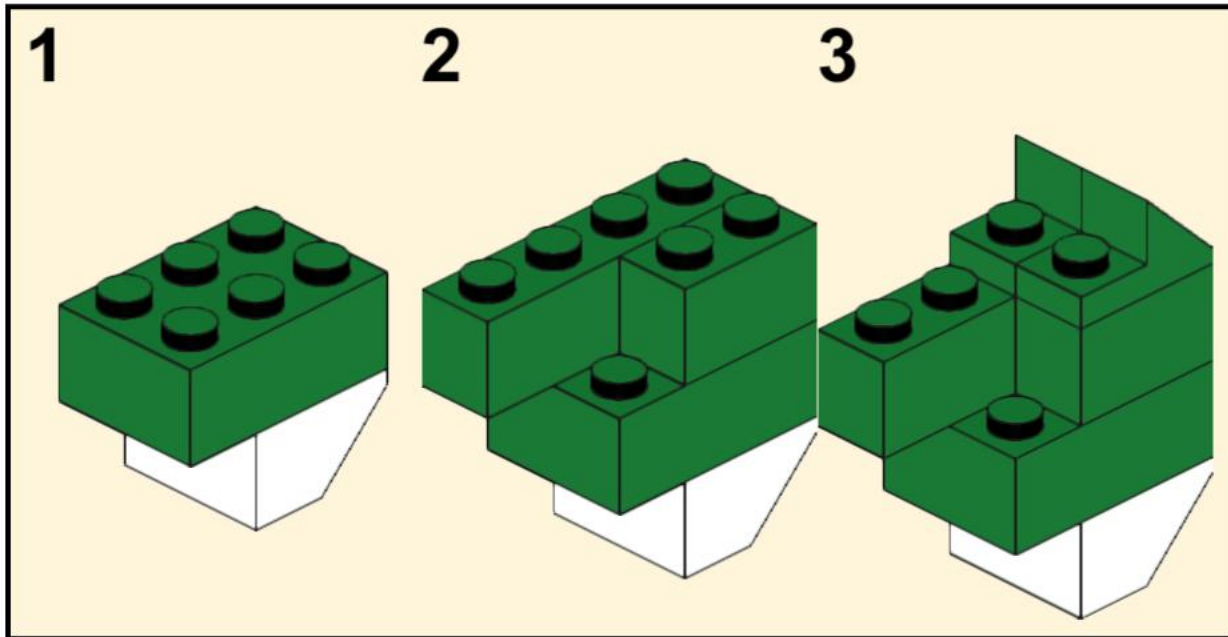
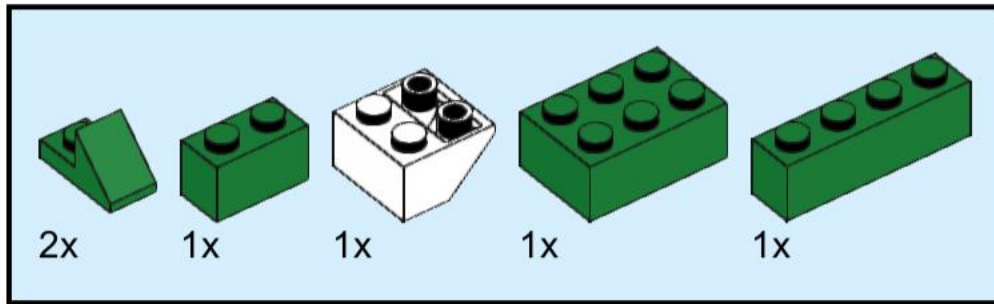

# 12

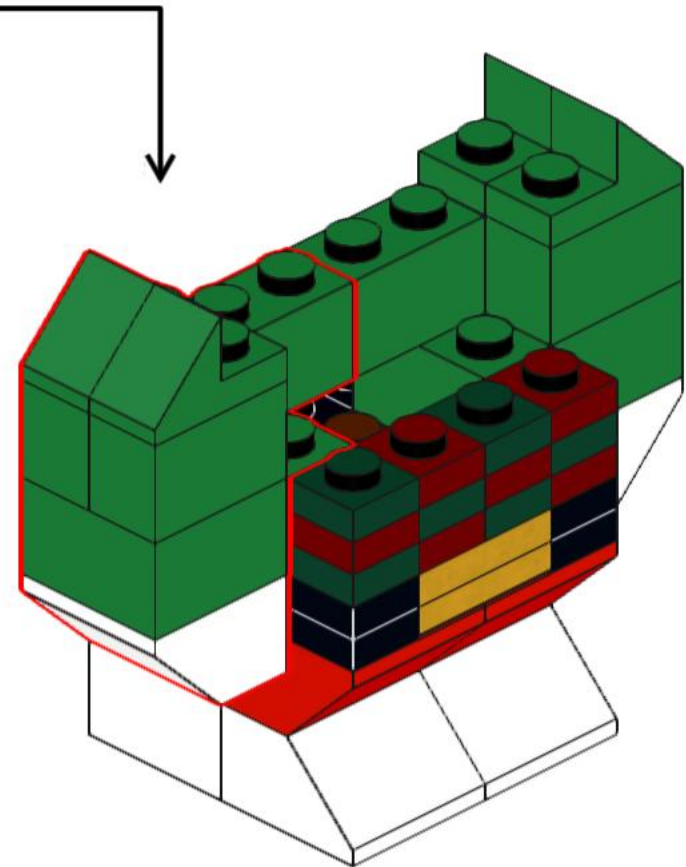
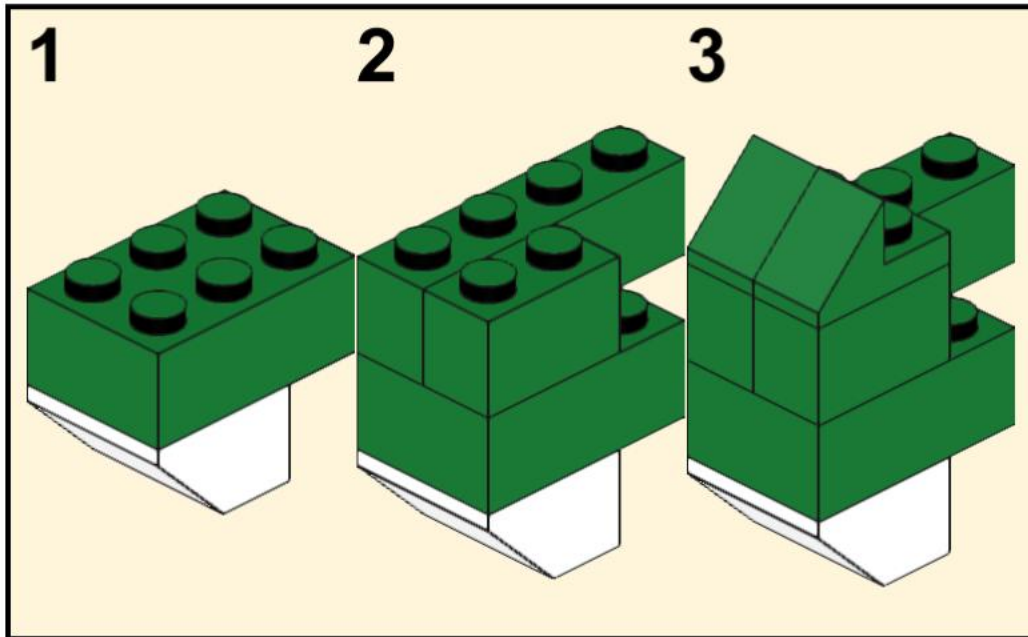
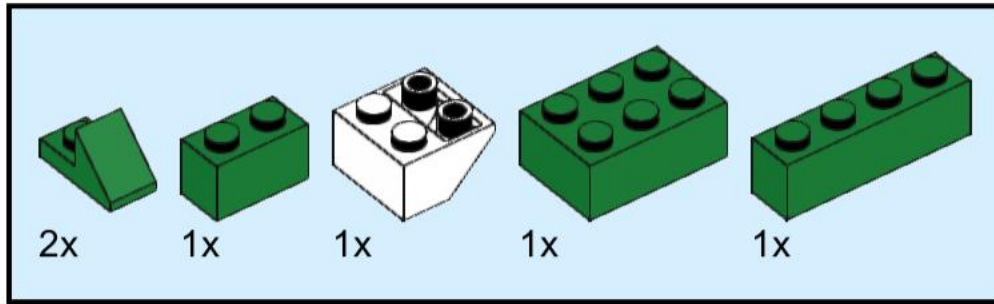

# 13

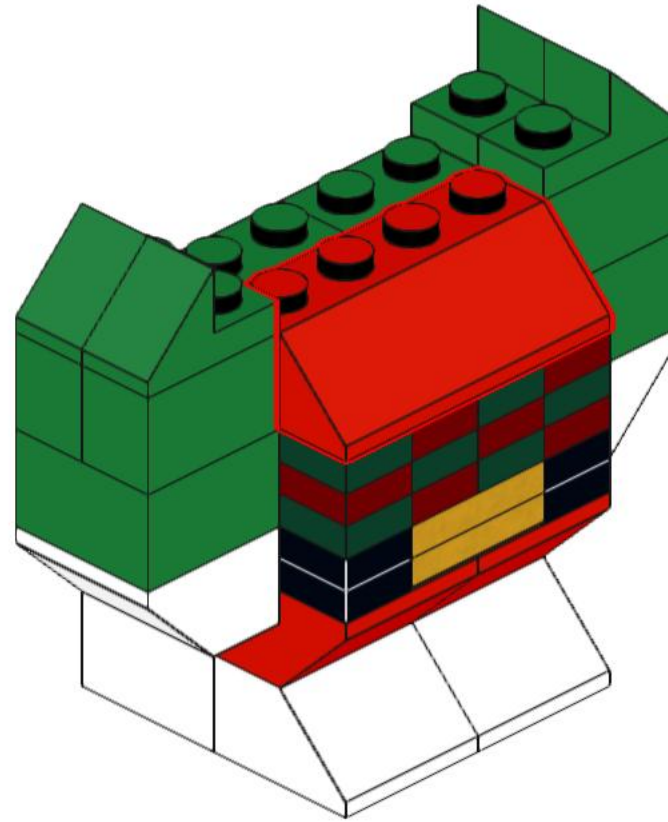
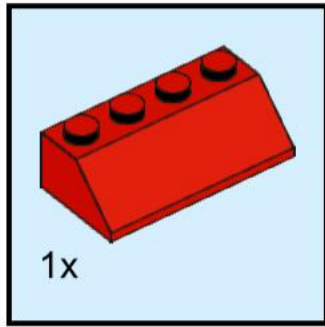

# 14

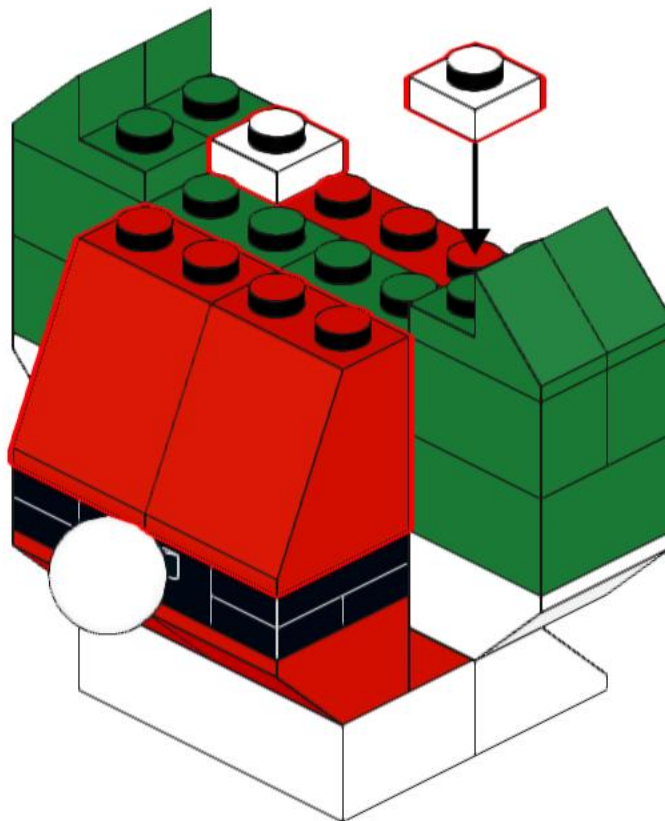
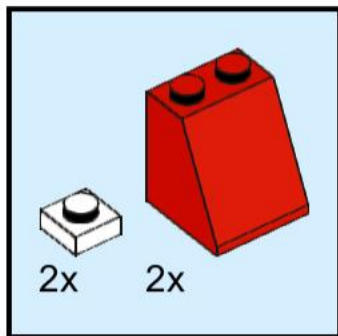

# 15

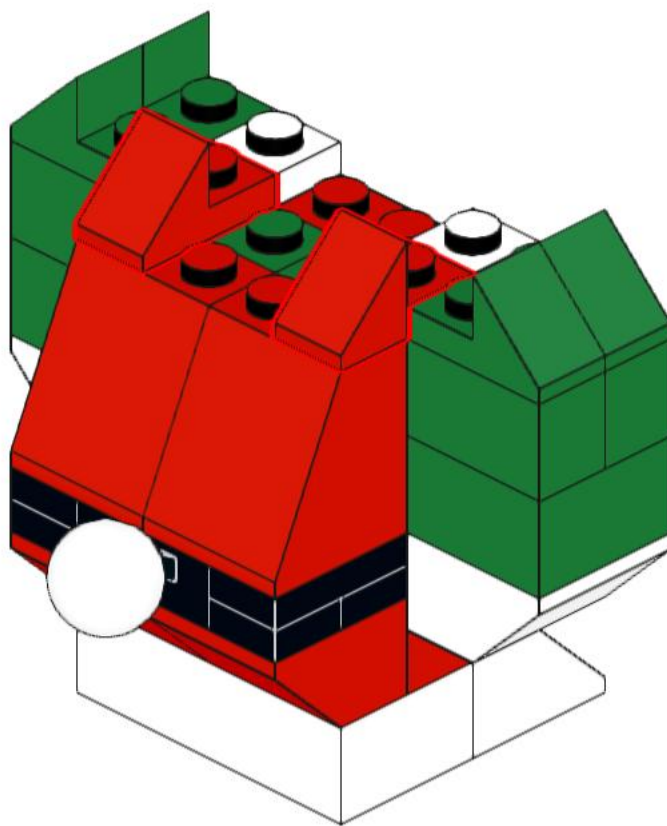
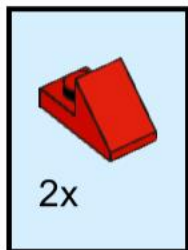

# 16

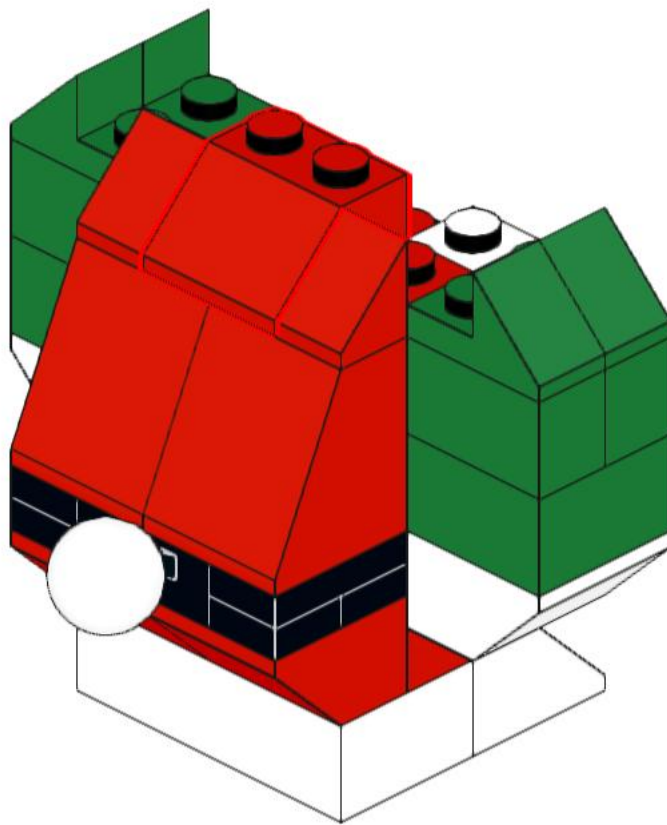
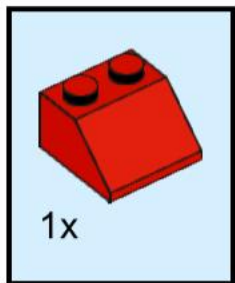



# 17

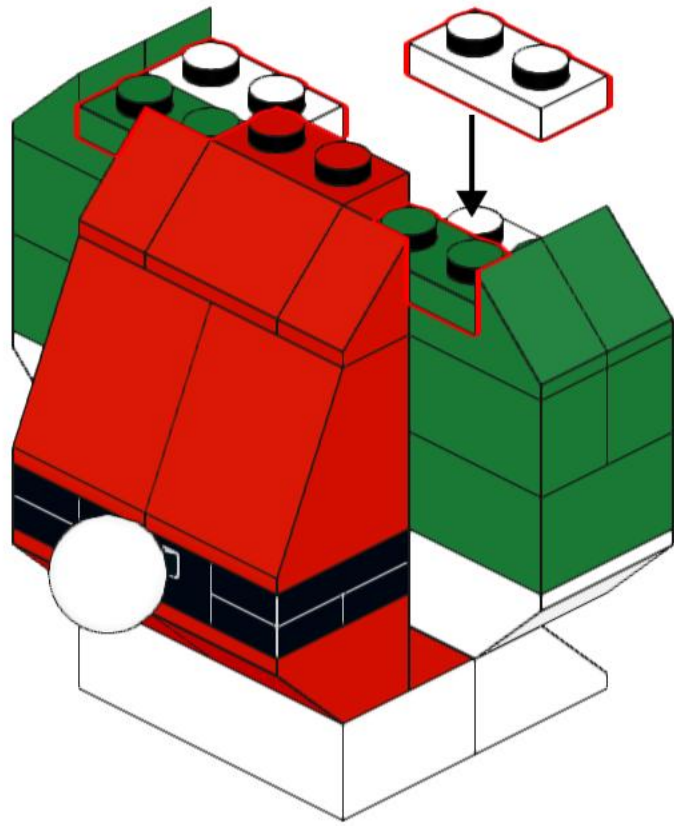
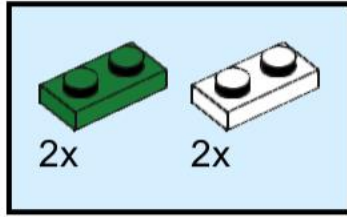

# 18

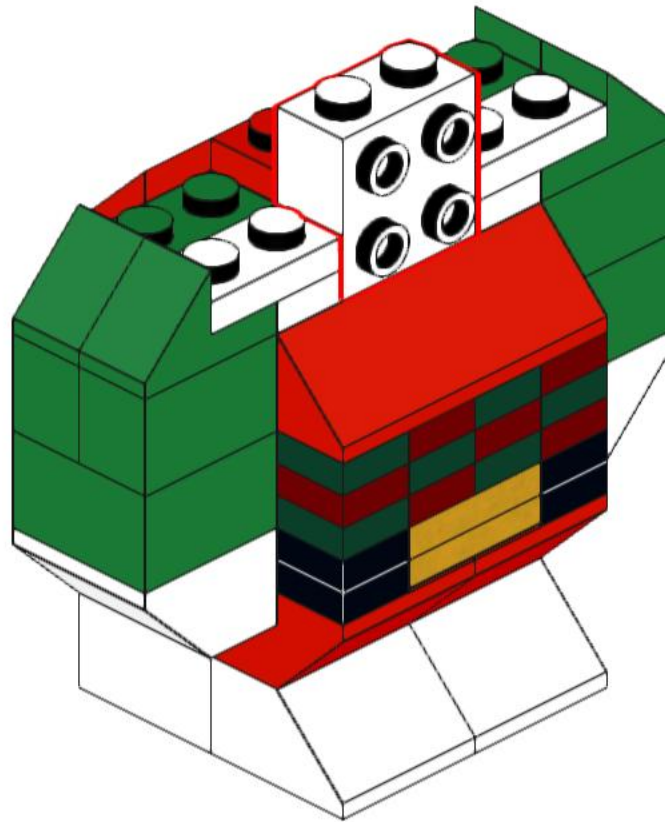
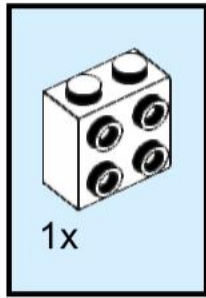

# 19

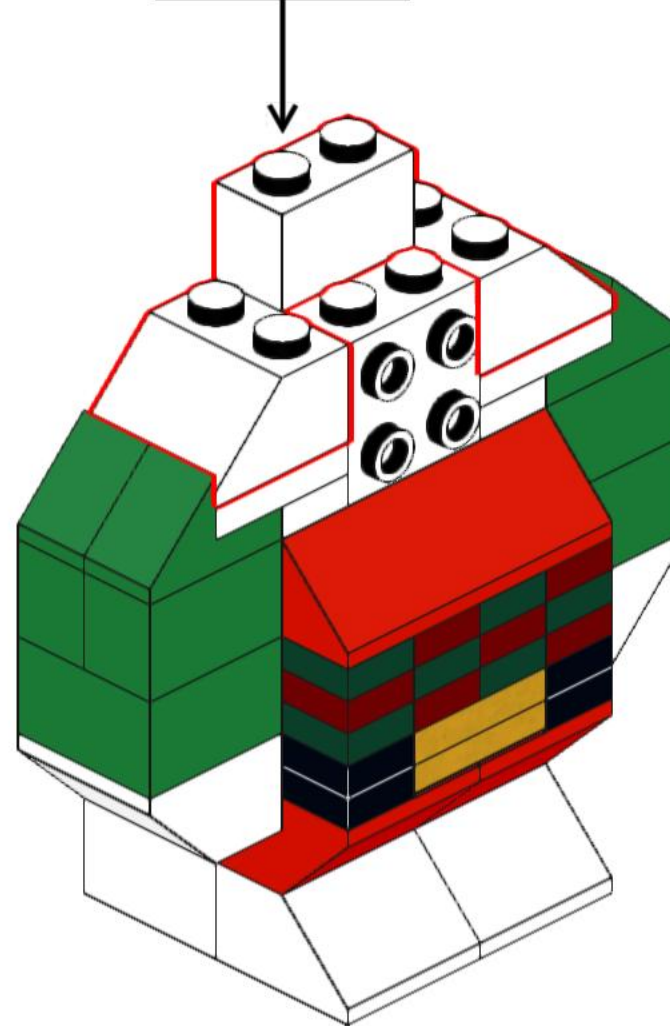
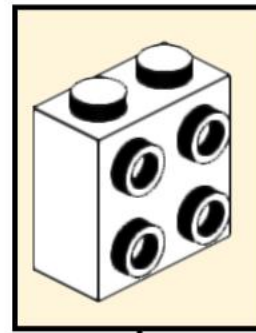
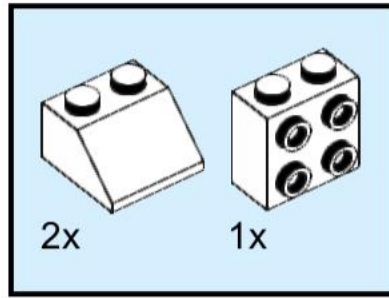

# 20

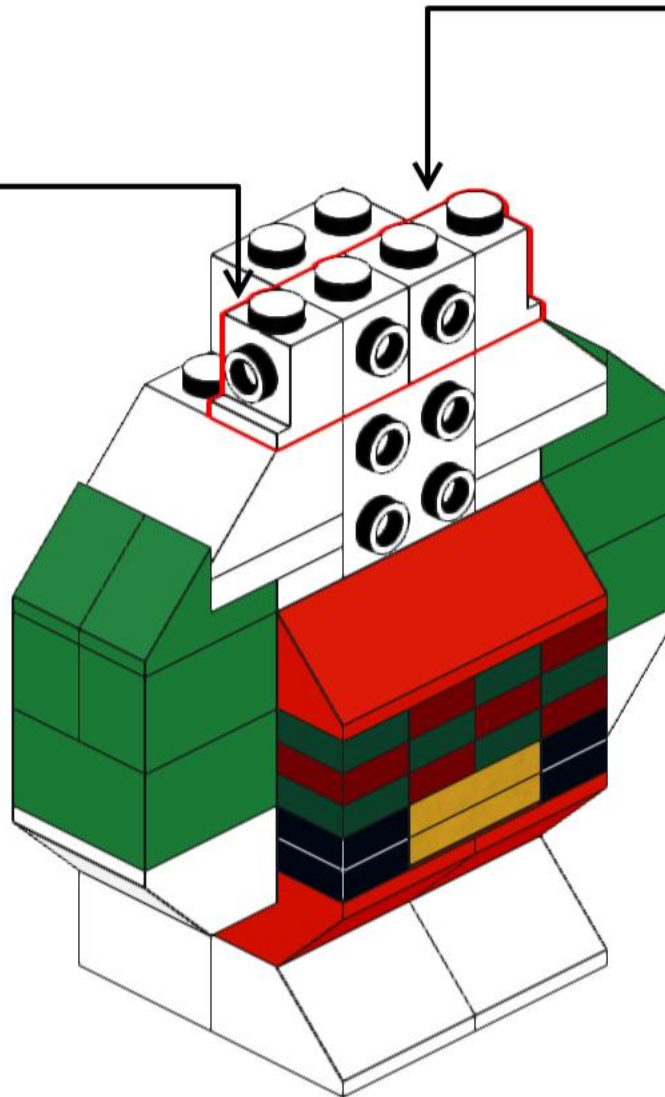
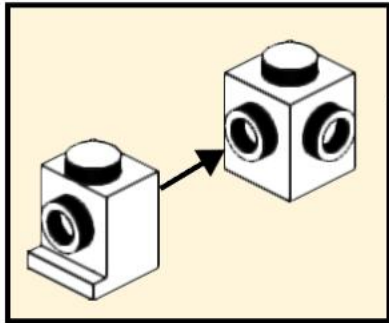
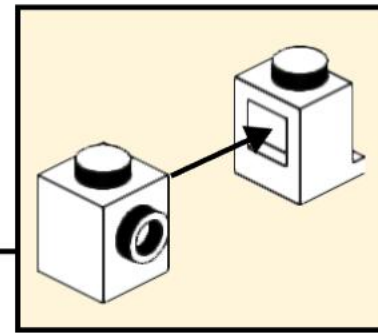
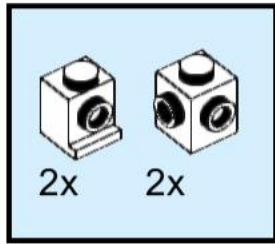

# 21

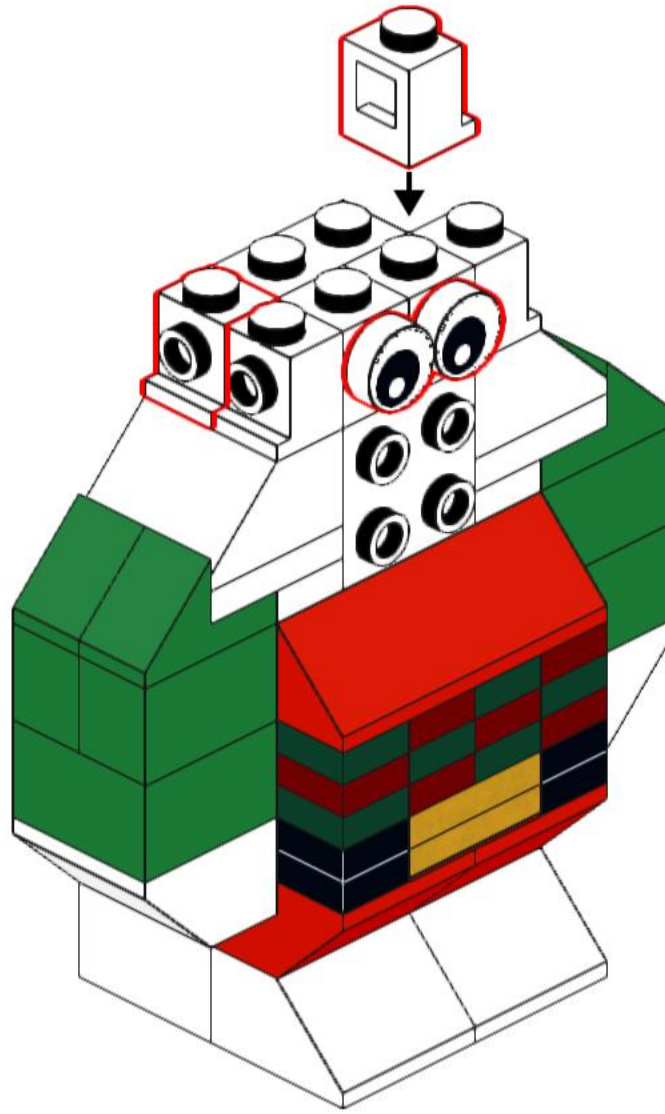
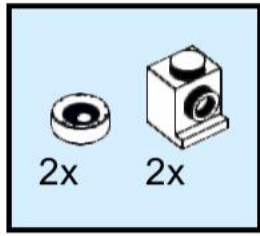

# 22

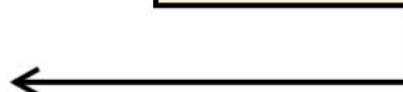
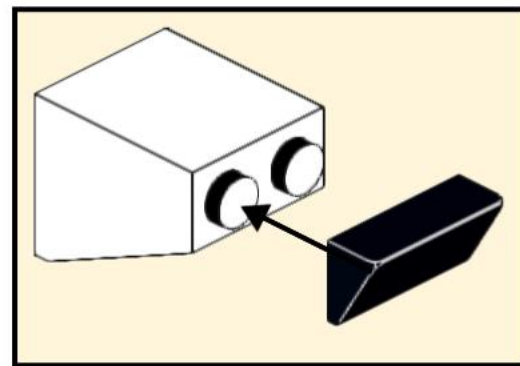
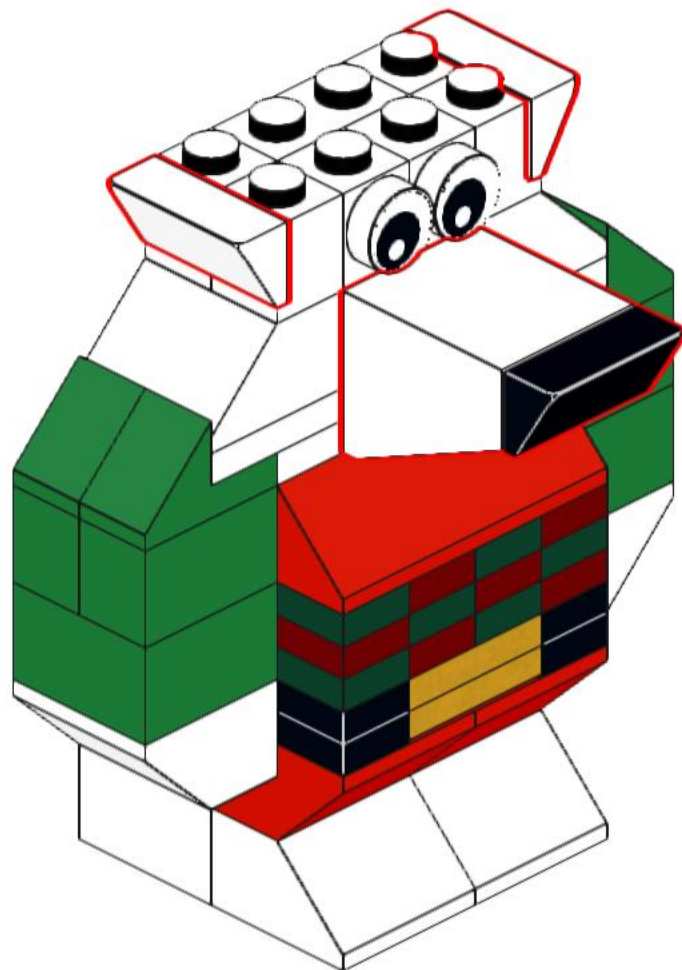
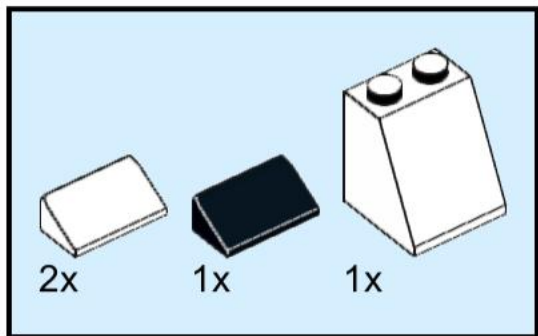

# 23

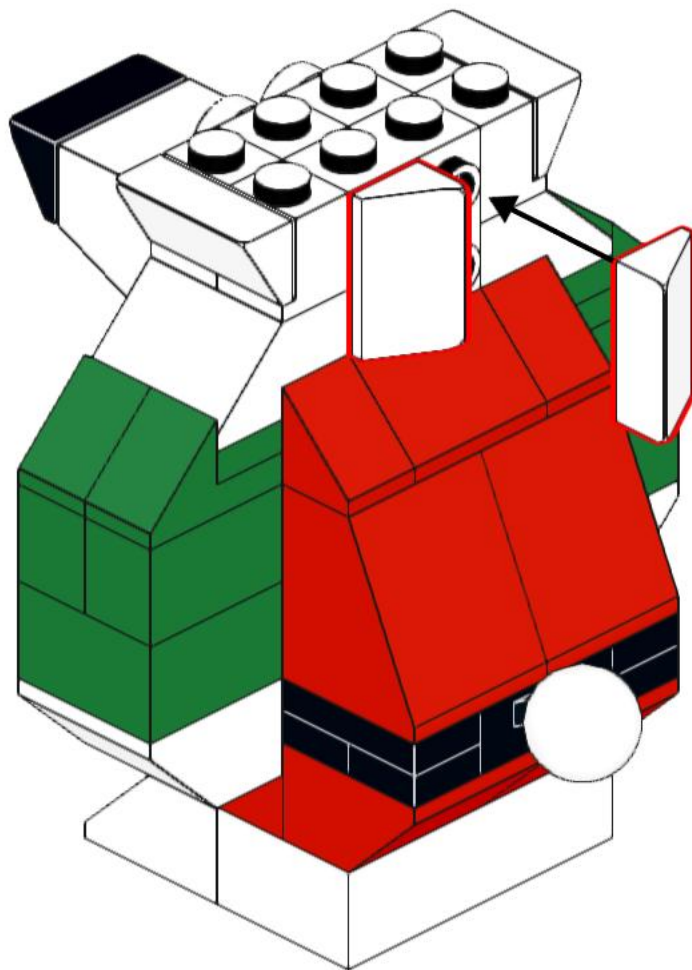
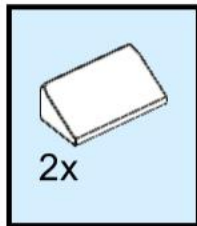

# 24

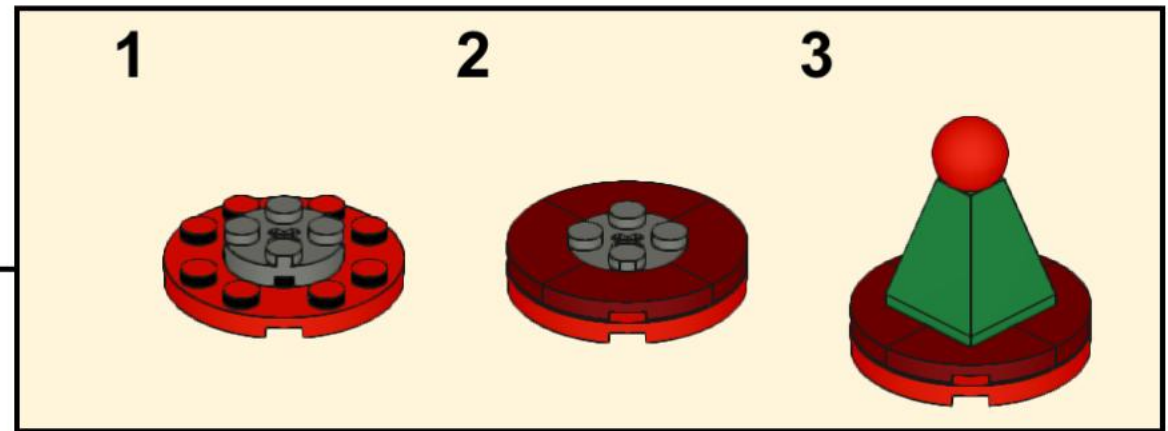
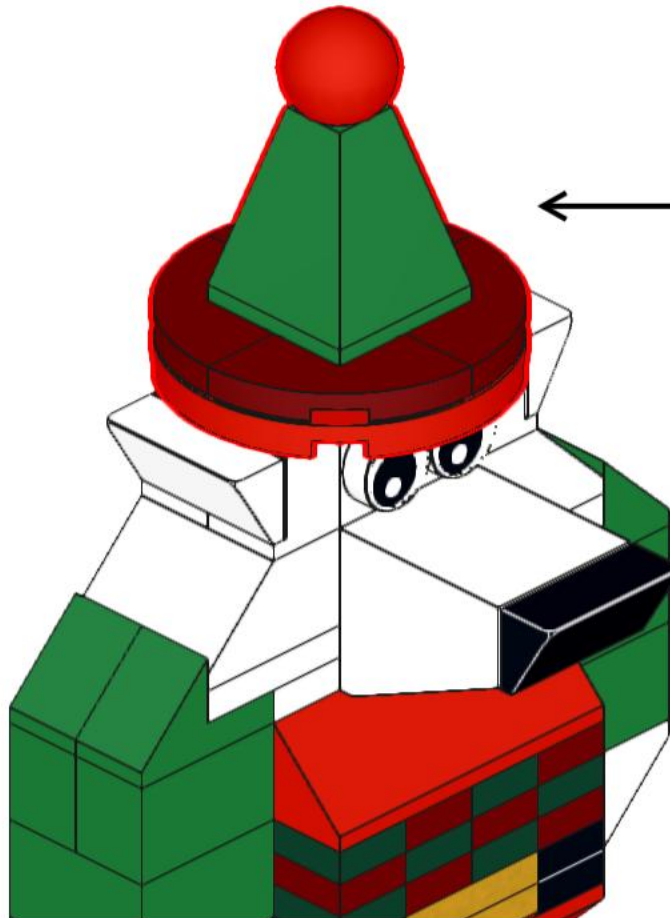
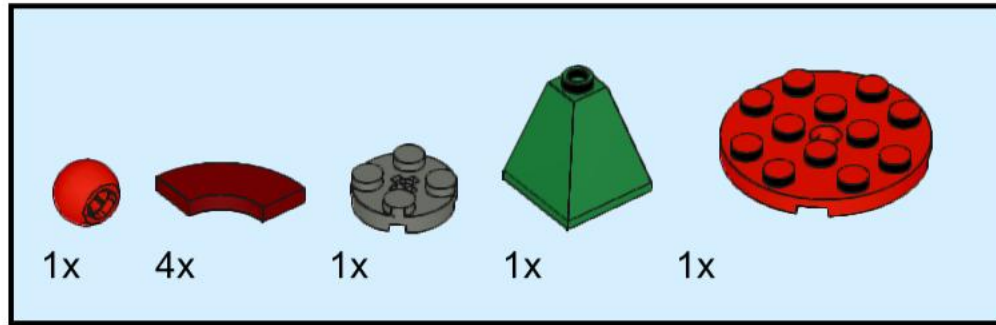



# 25

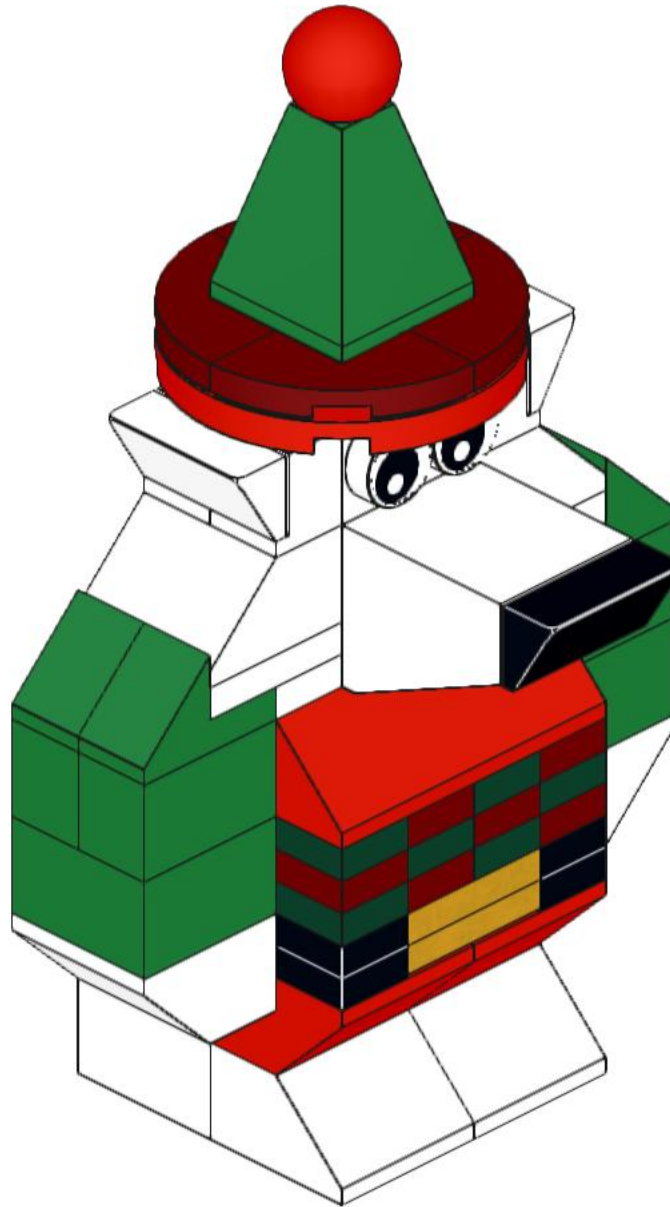



2x



2x



1x



2x



1x

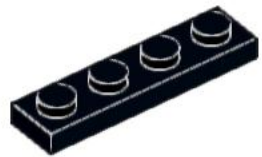

2x

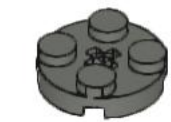

1x



2x

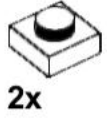

2x

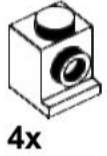

4x



1x



2x

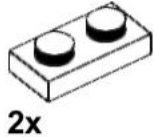

2x

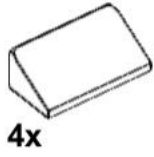

4x

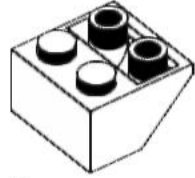

2x

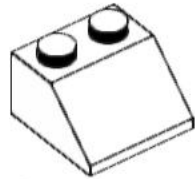

4x

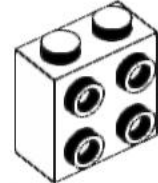

2x

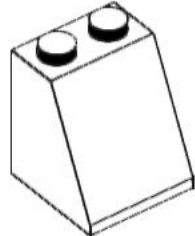

1x

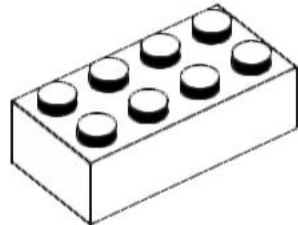

1x

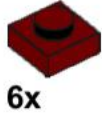

6x



4x



1x



2x

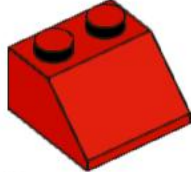

1x

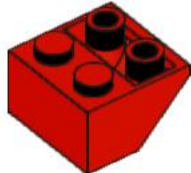

4x

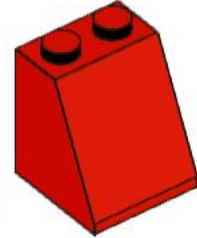

2x

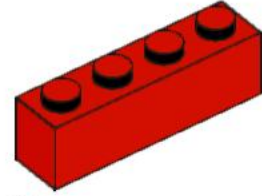

1x

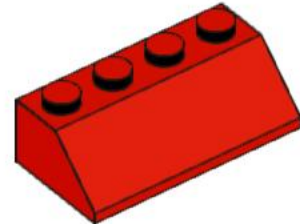

1x

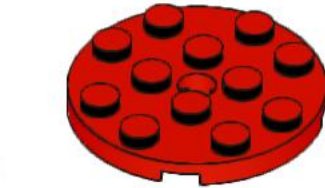

1x



1x

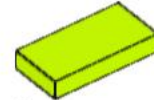

1x

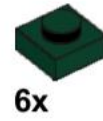

6x

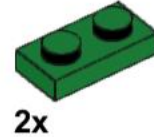

2x



4x

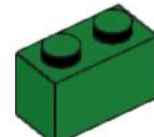

2x



1x

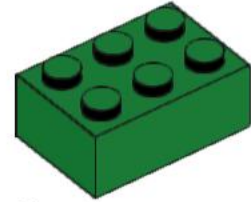

2x

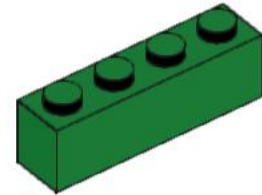

2x

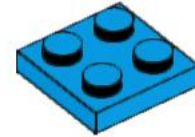

1x

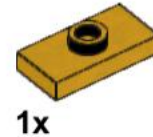

1x

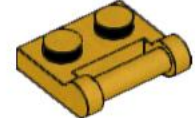

1x